

MINNESOTA Boating Guide 2021



Life jackets save lives. Wear it!

MINNESOTA BOATING GUIDE 2021

Enjoying Minnesota's lakes and rivers by paddle or motorboat is a wonderful privilege. That privilege comes with serious responsibilities. Fun boating is safe boating, so please read this guide thoroughly and contact the Department of Natural Resources (DNR) with any questions you may have.

This book summarizes Minnesota's boating laws and regulations. It does not present the actual laws and regulations. Laws and regulations are subject to change by the Legislature and through public hearings.

Boaters may also be subject to federal and local rules and restrictions. For boating information and more information regarding state laws and regulations, contact the DNR Information Center.

500 Lafayette Road
St. Paul, MN 55155-4040
651-296-6157
888-646-6367
Email: info.dnr@state.mn.us
mndnr.gov/boatingsafety

For watercraft registration and titling questions: mndnr.gov/licenses
651-296-2316

For federal boating laws visit the U.S. Coast Guard's boating safety website:
uscgboating.org

Front cover photo courtesy of:
National Safe Boating Council

LIFE JACKETS SAVE LIVES.

Top Five Boating Safety Tips

- Wear your life jacket – And make sure children wear theirs.
- Stay sober – Booze and boating don't mix. Alcohol is the #1 factor in boating fatalities.
- Tell a friend – Tell someone where you're going and when you will be back. If you're not back, they should call 911. Bring a phone or VHF radio.
- Be weather aware – Don't let a storm sneak up on you – delay your trip or head to shore. Go slow in rough water to avoid capsizing.
- Boat smart – Take a boating safety course. Know your boat; stay alert while scanning for dangers; stay seated and low in the boat to prevent falls overboard.

STAY ALERT – STAY ALIVE

IMPORTANT NOTES FOR 2021

- New carbon monoxide law requires certain motorboats to install carbon monoxide detectors and warning stickers by May 1, 2018. (Pg. 15)
- “Little Alan’s Law” has provided enhanced penalties for DWI violations - regardless of the vehicle being operated – including driver’s license and operation suspensions and revocations upon conviction, and for test failures and refusals, vehicle forfeitures, and driver’s license records.

TABLE OF CONTENTS

Boating in Cold Water	4
Licensing Your Boat	4
License Procedures and Fees.....	5
Hull Identification Number	8
License Certificate and Numbering	9
Expiration and Renewal.....	12
Duplicate Licenses	12
Transfer of Ownership	12
Destroying or Abandoning Your Boat	13
Dealer’s License.....	13
Collector Watercraft.....	13
Watercraft Titling.....	14
Required Equipment	15
Carbon Monoxide Detector.....	15
Life Jackets	15
Whistles/Horns.....	20
Navigation Lights	21
Fire Extinguishers	23
Ventilation.....	25
Flame Arrestors.....	25
Mufflers/Noise Limits	25
Marine Toilets	26
Protect Your Waters	26
General Operation	29
Enforcement.....	29
Age of Operators.....	30
Navigation Rules	31
Move Over Law	32
Waterway Markers – Aids to Navigation ...	32
On the Water Laws and Rules	35
Capacity and Overloading.....	36
Boating While Impaired (BWI).....	36
Towed and Wake Sports	38
Personal Watercraft	40
Renting Watercraft.....	46
Accidents.....	46

Other Water Activities	47
Paddling	47
Scuba Diving	48
Swimming Areas	49
Temporary Structures, Docks and Buoys	50
Special Events.....	51
Public Waters and Water Appropriation Permits.....	52
Aquatic Plant Management Permits.....	52
Local Boating Restrictions	54
Boat Trailers	54
Boating Emergencies	56
Rescue Breathing for Drowning Victims...	56
Falling Overboard	57
Capsizing or Swamping	58
Cold Water	58
Propeller Injuries	59
The “Circle of Death”	59
Carbon Monoxide Poisoning	60
The Drowning Machine	62
Float Plan	62
Boating Courses	63
Boating on Lake Superior	63
Visual Distress Signals	64
Security	65
Public Water Access	66
Wildlife Management Areas	67
Sunken Boats and Vehicles	67
Sunrise and Sunset	68
Agency Directory	70
Operator Float Plan	73
Free Publications	Inside back cover



BOATING IN COLD WATER

RESIST THE URGE TO FIGHT THE WATER: REST AND RECOVER.

If wearing a life jacket, the 1-10-1 principle may save your life:

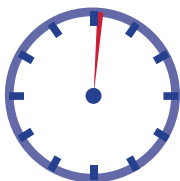

1 minute

- Get breathing under control.

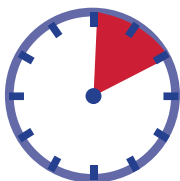

10 minutes of meaningful movement

- Assess the situation and make a plan.
- Perform most important functions first, such as locating other party members.
- Self-rescue if possible.
- Signal or call for help.

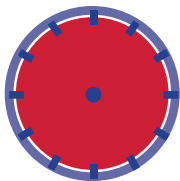

1 hour (or more) of useful consciousness

- Focus on slowing heat loss.

LICENSING YOUR BOAT

All motorized watercraft regardless of length and nonmotorized watercraft over 10 feet must be licensed by the Department of Natural Resources (DNR). The types of watercraft that must be licensed include, but are not limited to, motorboats, rowboats, sailboats, sailboards, stand-up paddleboards,

canoes, kayaks, paddle boats, rowing shells or sculls, all-terrain vehicles used in the water and inflatable craft.

Exceptions to this law are as follows:

- Watercraft currently registered in another state and not kept in Minnesota for more than 90 consecutive days, or a watercraft owned by a person from another state that does not require licensing of that type of watercraft and it is not within Minnesota for more than 90 consecutive days.
- Watercraft from a country other than the United States and not kept in Minnesota for more than 90 consecutive days.
- Watercraft owned by the United States government or other specified governmental units, except those boats used for recreational purposes.
- Watercraft documented with the United States Coast Guard (official papers on craft 5 net tons or larger are issued by the Coast Guard instead of state registration).
- A ship's lifeboat.
- Waterfowl boats used during the waterfowl hunting season, rice boats used during the harvest season and seaplanes.
- Nonmotorized watercraft 10 feet in length or less.

LICENSE PROCEDURES AND FEES

Register your watercraft in person at any deputy registrar of motor vehicles (where you license your car); at the DNR License Center in St. Paul; or renew online at mndnr.gov/licenses

Fees for Watercraft Registration and Titling (effective 07/01/2020)

6

Type and Length	3 Yr. Fee	Invasive Species Surcharge	ELS Fee per Transaction	Filing Fee	Total Cost
Watercraft owned by nonprofit organization and used substantially to teach water safety (camp, Boy Scouts, etc.)	\$4.50	\$10.60	\$1.50	\$7.00	\$23.60
Rental or lease watercraft up to and including 19 feet (Rental watercraft over 19 feet—see categories below for fees)	\$9.00	\$10.60	\$1.50	\$7.00	\$28.10
Canoes, kayaks, sailboards, paddle boats, paddleboards and rowing shells (nonmotorized boats 10 feet or less are exempt from registration)	\$10.50	\$10.60	\$1.50	\$7.00	\$29.60
Sailboats up to and including 19 feet (Sailboats over 19 feet same as pleasure craft)	\$10.50	\$10.60	\$1.50	\$7.00	\$29.60
Pleasure watercraft less than 17 feet	\$18.00	\$10.60	\$1.50	\$7.00	\$37.10
Pleasure watercraft 17–19 feet	\$27.00	\$10.60	\$1.50	\$7.00	\$46.10
Pleasure watercraft over 19 feet but less than 26 feet	\$45.00	\$10.60	\$1.50	\$7.00	\$64.10
Pleasure watercraft 26 feet but less than 40 feet	\$67.50	\$10.60	\$1.50	\$7.00	\$86.60

Type and Length	3 Yr. Fee	Invasive Species Surcharge	ELS Fee per Transaction	Filing Fee	Total Cost
Pleasure watercraft 40 feet and over	\$90.00	\$10.60	\$1.50	\$7.00	\$109.10
Personal watercraft, rental or personal	\$37.50	\$10.60	\$1.50	\$7.00	\$56.60
Dealer's license, regardless of the number of watercraft owned by the dealer	\$67.50	\$10.60	\$1.50	\$7.00	\$86.60
Any watercraft more than 19 feet long for hire with an operator	\$75.00	\$10.60	\$1.50	\$7.00	\$94.10
Transfer of registered boat without renewal	\$4.50	\$0.00	\$1.50	\$7.00	\$13.00
Watercraft Title (see page 14)	\$15.00	\$0.00	\$0.00	\$7.00	\$22.00
Duplicate Title	\$4.00	\$0.00	\$0.00	\$7.00	\$11.00
Transfer Title	\$10.00	\$0.00	\$0.00	\$7.00	\$17.00
Duplicate Registration Card	\$4.50	\$0.00	\$1.50	\$4.50	\$10.50
Duplicate Decal	\$0.00	\$0.00	\$1.50	\$4.50	\$6.00

For each title transaction, new registration or any transaction involving a transfer, the filing fee is \$7.00. For each renewal or duplicate registration transaction, the filing fee is \$4.50. NOTE: \$7.00 filing fee is only charged once per boat transaction. The \$1.50 ELS fee is not charged on any title transaction.

When you register your boat you will need to provide:

- The boat length, which is the straight-line distance from the bow (front of the boat) to the stern (rear of the boat). Bowsprits, outboard motor brackets, rudders and other attachments are not included in the measurement.
- Boat's manufacturer.
- Type of hull material (wood, metal, or plastic).
- Type of propulsion.
- Boat model.
- Boat year.
- Hull identification number (HIN).
- Paddleboards do not require a HIN.
- Sales receipt that shows you have paid the sales tax.

Watercraft licenses cover a period of three calendar years and expire on December 31 of the last year the license is valid. The expiration date appears on both the license certificate and on the validation decals which are applied to the boat.

HULL IDENTIFICATION NUMBER

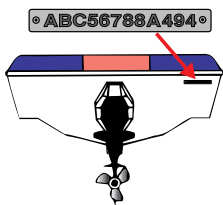

A hull identification number (HIN) or serial number is vital in registering and titling your boat.

HINs can be found on all boats manufactured since model year 1973. The letter-number combination is typically about 12–17 digits long (example: ABC12345L402). HINs are usually found on the right side of the stern or transom of the craft on the outside and may be stamped into

the fiberglass or aluminum or appear on a separate plate.

Location may vary slightly on pontoon boats, personal watercraft, kayaks, canoes, etc. Boats built before November 1972 should have a shorter serial number somewhere on the craft.

LICENSE CERTIFICATE AND NUMBERING

If you apply for a new boat registration or renew an existing one in person at a deputy registrar (where you license your car) or the DNR License Center, you will receive your boat license decal and registration card on the spot.

If you apply through the mail, it will probably take several weeks before you receive your decal and card.

Sign your license and keep it on board your watercraft. If you are operating a nonmotorized watercraft, you don't have to carry the license with you. However, if an enforcement officer asks to see it, you must produce it within a reasonable time.

The license number issued to your boat appears on the license card and must be displayed as follows:

- Numbers must be placed on each side of the forward half of the hull (see illustration on page 10).
- Remove the expired decals first, before applying the new ones.
- The license number must be displayed on your boat as it appears on your license card.
- Letters and numbers must be at least 3 inches high.

- Letters and numbers must be of a block character.
- The MN should be separated from the numbers by a 3-inch space.
- Letters should be separated from numbers by a 3-inch space.
- Must contrast with the background.
- Can be either painted or attached to the craft.
- Should read from left to right and must always be legible.
- The current license decal is always placed closer to the stern within 4 inches of the license number.

The license number which appears on your watercraft license card must be displayed on your boat as shown below:

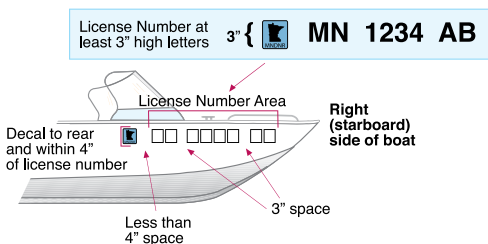
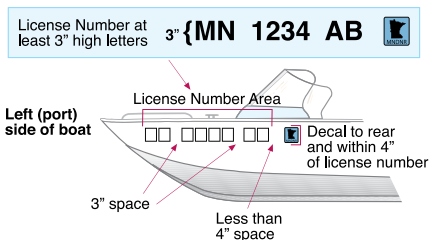

If your canoe, kayak, paddleboard, rowing shell, paddle boat, sailboard or sailboat does not have a motor, a license decal is all that is required. No 3-inch numbers are necessary. Place the decal on each side of the forward half of the nonmotorized craft as shown below:



The owner of rented watercraft may keep the license certificate at the rental location. The rental business must be printed on both sides of the rear half of the watercraft in letters at least 3 inches high.

No other number, letter, or design may appear within 24 inches of the license number or decal.

On sailboards, paddleboards and nonmotorized sailboats, you may place the decals on the stern. Only do this if it is impossible, because of the boat's design, to place them on the bow. For inflatable or foam paddleboards, attach decals to a placard attached to the paddleboard.

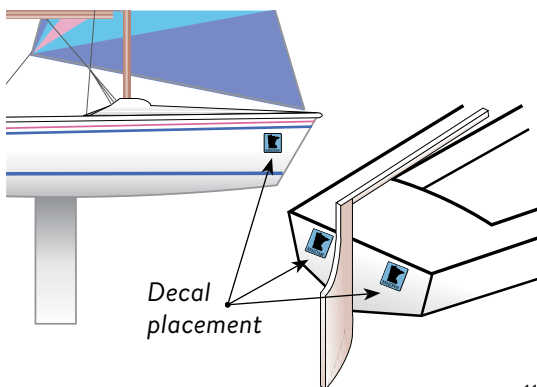

If your canoe or sailboat is motorized, affix the 3-inch letters and numbers as previously described for other motorized craft. The square decal should be placed to the stern or to the rear of the number (see page 10).

EXPIRATION AND RENEWAL

All watercraft licenses expire on Dec. 31 of the last year the license is valid.

When you obtain your new license certificate and validation decals, discard your old license certificate and replace the expired decals on your boat with the new ones. Remember, only the current set of decals must be displayed.

DUPLICATE LICENSES

If a license is lost or destroyed, stop by your local deputy registrar of motor vehicles office or the DNR License Center 651-296-2316, 800-285-2000 or mndnr.gov/licenses

To apply by mail, write to the DNR License Center. Be sure to sign your name on the letter and include the registration number, description of the boat and the hull identification number (HIN).

The fee for a duplicate license is listed on the watercraft license fee chart on page 7.

TRANSFER OF OWNERSHIP

If you buy a boat that is currently licensed in Minnesota:

- Obtain a bill of sale from the previous owner. If boat is titled, obtain the watercraft title certificate.
- Send or deliver it, along with an application for transfer and the transfer fee listed on

the fee chart on page 7, to the DNR License Center or deputy registrar.

- Transfer applications must be made within 15 days after the transfer actually occurs.
- The transferred registration is valid only for the time remaining on the previous owner's registration. Then you must renew your license.
- Sales between private parties do not require payment of sales tax.

DESTROYING OR ABANDONING YOUR BOAT

If you destroy or abandon your watercraft – or if you license it in another state – notify the DNR License Center 651-296-2316 within 15 days.

DEALER'S LICENSE

Boat and motor dealers, wholesalers and manufacturers may apply for a dealer's license for watercraft used for demonstration purposes or for purposes necessary to conduct business. A dealer will be issued only one number. This number must be displayed on both sides of boats used for these purposes, however, and may be detachable. This number must be removed before sale.

COLLECTOR WATERCRAFT

Owners of watercraft that were built before July 1, 1959, and used solely as a collector's item, have the option of displaying the boat registration number and current decal on the forward half of the boat, placed on both sides on a detachable plate or board.

The number size, type and decal placement is the same as noted on pages 9–12 of this guide.

WATERCRAFT TITLING

Certain watercraft over 16 feet are required to be titled in Minnesota.

A watercraft title provides proof of ownership, which becomes very important when buying or selling a boat. A title also protects businesses that make boat loans, and aids in the recovery of stolen watercraft.

Exceptions to this law are watercraft:

- Currently registered in another state and never used in Minnesota for more than 90 consecutive days.
- Manufactured before Aug. 1, 1979.
- 16 feet or less in length.
- Rowboat with oar locks and an outboard motor less than 40 hp.
- Documented with the United States Coast Guard (official papers on craft 5 net tons or more are issued by the Coast Guard instead of state registration).
- Canoe, kayak or ship's lifeboat.
- Waterfowl boats used during the waterfowl hunting season, rice boats used during the harvest season and seaplanes.
- Owned by a manufacturer or dealer and is held for sale.
- Used by a manufacturer for testing purposes only.
- Owned by a resort or recreational camping area licensed by the Minnesota Department of Health.
- Rowing shell or scull.
- Owned by the United States, a state or a political subdivision.

REQUIRED EQUIPMENT

CARBON MONOXIDE (CO) DETECTOR

Sophia's Law requires that all recreational motorboats, including sailboats with motors, with enclosed compartments be equipped with a functioning marine CO detection system and/or display three CO poisoning warning stickers as of May 1, 2018.

Full details and requirements can be found at mndnr.gov/boatingsafety.

LIFE JACKETS

The following are life jacket requirements in Minnesota:

- State law requires children under 10 years old to wear a properly fitted life jacket while a boat is underway. Underway means not securely fastened to a permanent mooring or tied to a dock.
- A readily accessible and wearable life jacket **is required for each person onboard a boat**, this includes canoes, kayaks, stand-up paddleboards, paddleboats and waterfowl boats.
- **One Type IV throwable is required on boats 16 feet or longer** (except canoes and kayaks) and must be immediately available.
- Personal watercraft operators and passengers must each wear a life jacket.



FOR YOUR SAFETY, WE STRONGLY RECOMMEND EVERYONE ON BOARD WEARS A LIFE JACKET AT ALL TIMES.

Check the label on the life jacket to make sure it is a U.S. Coast Guard-approved flotation device and how to safely use it.

The following are exempt from state life jacket carriage laws:

- sailboards
- rowing team members specified in law and accompanied by a chase boat carrying the required life jackets



MANDATORY CHILD LIFE JACKET WEAR LAW

Minnesota law requires a properly fitted U.S. Coast Guard-approved life jacket to be worn by children less than

10 years old when aboard any watercraft while underway. Underway means not attached to a permanent mooring or tied to a dock.

There are exceptions to the wear law for:

- children who are below the top deck or in an enclosed cabin.
- children aboard passenger vessels being operated by a licensed captain.
- children on a boat that is anchored for the purpose of swimming or diving.

Some infants are too small for any life jacket, even though the label may say 0–30 pounds. In general, babies under 6 months or 16 pounds are too small for a life jacket

to be effective due to the size of their head compared to their body.

If your infant is under 6 months old or 16 pounds, please wait until the baby is a little older before taking them boating.

NOTE: Fastening a boat cushion to a car seat is not considered a lawful flotation device for an infant and could trap the baby underwater if your boat capsized.

WEARABLE LIFE JACKET TYPES

There are four types of wearable life jackets approved for use on recreational boats:

Off-Shore Life Jacket

(Type I) is a vest or yoke-type device generally found on commercial craft. It is designed to turn most unconscious persons from a face downward to a face up position in the water.



Near-Shore Buoyant Vest

(Type II) usually looks like a horse collar and is worn like a bib. It has an unconscious turning ability similar to the Type I, but it will not turn as many persons under the same conditions.



Flotation Aids (Type III) are usually foam-filled and come in several colors and styles, including full-sleeved jackets. Type III devices may also include inflatable life jackets. Type IIIs are not designed to turn an unconscious victim, but they do provide protection against exposure to cold water.



Special Use Devices (Type V) are designed and approved for use during particular activities. Type Vs include some inflatable life jackets, duck hunting flotation coveralls, and flotation aids made for sailboarding and whitewater rafting. The label will indicate any restrictions that apply to the particular device. Some Type Vs must be worn to be counted in the total number of life jackets on board your boat.



Inflatable Life Jackets are U.S. Coast Guard approved for boaters 16 years and older. Inflatables have the advantage of being comfortable and easy to wear. Once inflated, the flotation is equal to or greater than traditional life jackets.



Inflatables do have some disadvantages:

- Must be inflated to provide flotation.
- Do not provide as much cold water protection.



- Require regular maintenance and rearming after inflation.

Some inflatable life jackets are required to be worn in order to be counted as one of your U.S. Coast Guard-approved wearable flotation devices – check the label for indication. Inflatables are not approved for use on personal watercraft or while water-skiing or similar sports. Always read the label for intended use and follow any restrictions.

Before purchasing, make sure that “U.S. Coast Guard Approved” is visible somewhere on the package or on the device itself.

THROWABLE FLOTATION AIDS

Throwable Devices

(Type IV) - buoyant cushion, ring buoy or horseshoe buoy – are designed to be thrown to a victim in the water, rather than worn. Cushions should be checked often to see if they are in serviceable condition. **One Type IV throwable is required on boats 16 feet or longer** (except canoes and kayaks) and must be immediately available.

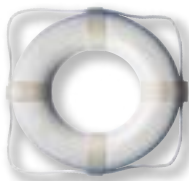

OTHER FACTS ABOUT LIFE JACKETS

- The life jacket must be of the appropriate size for the intended wearer.
- “Readily accessible” means easily retrievable within a reasonable amount of time in an emergency. Life jackets in sealed bags, under heavy objects or in locked containers are not accessible.

- “Immediately available” means Type IV throwable devices must be easily reached in time of an emergency. Generally this means in the open, not in a container.
- A label stating “U.S. Coast Guard approved” must be printed on or attached to the device and you must follow all restrictions on it.
- All life jackets must be in serviceable condition, meaning free of tears, rot, punctures and waterlogging. All straps, zippers and buckles are present and in good shape.
- A U.S. Coast Guard-approved life jacket must be worn by a person being towed on any device, or be carried in the towing watercraft.
- A U.S. Coast Guard-approved Type V device may be substituted for any other approved device if it meets the same requirements and is noted on the Type V device (i.e. “Equivalent to an approved Type III device”).

WHISTLES/HORNS REQUIREMENTS

- Motorboats 16 feet to less than 26 feet long must be equipped with a hand-, mouth-, or power-operated whistle or horn capable of producing a continuous sound for two seconds and audible for at least one-half mile.
- Motorboats 26 feet to less than 40 feet long must be equipped with a hand- or power-operated horn or whistle capable of producing a continuous sound for two seconds and audible for at least one mile.
- Motorboats 40 feet or longer must be equipped with a power-operated horn or whistle capable of producing a continuous

sound for at least two seconds and audible for at least one mile.

- The only boat that can carry a siren is a government patrol craft.

NAVIGATION LIGHTS

Navigation lights must be on from sunset to sunrise.

MOTORBOAT NAVIGATION LIGHT REQUIREMENTS

Most motorboats 16 feet or longer will likely be equipped with the correct navigation lights by the manufacturer. Only U.S. Coast Guard-approved lights will meet the following requirements.

Motorboats less than 65 feet long while underway, including sailboats operating under engine power, require lights that are:

- Either separate 112.5° red and green side lights **or** a combination 225° red and green bow light. **(A)**
- A 225° masthead white light on the forward half of the boat, placed at least 3 feet above the red-green lights, showing 112.5° to each side and visible for three miles. **(B)**

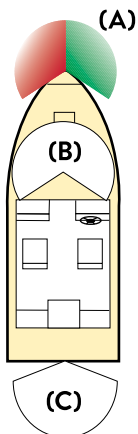

Less than 65 feet long.

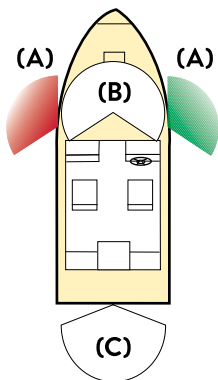

- On boats 40 to 65 feet long, this light **(B)** must be at least 9 feet above the gunwale.
- A 135° white light on the stern half of the craft showing 67.5° to each side. **(C)** This light may be carried off the center line.
- When at anchor, only one 360° white light is necessary.

OPTIONAL: Motorboats less than 40 feet long while underway, including sailboats operating under engine power, may follow the lighting requirements below or the requirements listed in the previous section:

- Either separate 112.5° red and green side lights or a combination 225° red and green bow light. **(A)**
- A 360° white stern (rear) light. When at anchor, only the 360° white light is necessary. **(D)**

NONMOTORIZED BOAT NAVIGATION LIGHT REQUIREMENTS

- Must at least carry a white lantern or flashlight.
- Light should be strong enough so that other boats around the horizon can see it at least two miles away.
- Light must be displayed in sufficient time to avoid a collision with another watercraft.

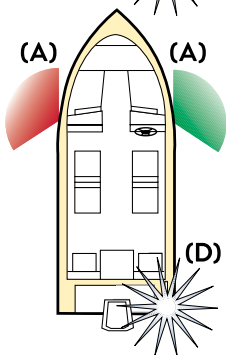
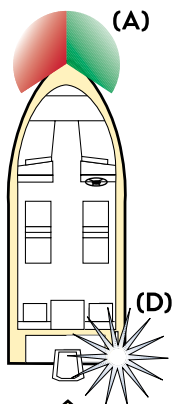

- Canoes, sailboats, etc., that are operating under power must follow the lighting rules for motorboats.

VISIBILITY RULES

- White lights must be visible for 2 miles on a dark, clear night (with one exception under the International Rules).
- Combination or side lights must be visible for 1 mile.
- Combination or side lights must shine red to port (left side) and green to starboard (right side).
- Combination lights must be attached so the light shows from directly ahead to 22.5° to the rear of the beam (midpoint of the boat) on the respective side.
- Lights may be detachable and need only be displayed from sunset to sunrise.

LIGHTING NOTES

- Check navigation light sockets and wiring for corrosion.
- Boats on waters subject to U.S. jurisdiction may also display navigation lights under current federal inland regulations.
- All accessory lighting such as docking lights, spotlights or accent lights must not impact navigation light visibility as required by law.

FIRE EXTINGUISHERS

All fire extinguishers must be U.S. Coast Guard approved, fully charged, and readily accessible.

Motorboats carrying or using fuel or other flammable fluid in an enclosure are required to have a Type B, U.S. Coast Guard-approved fire extinguisher(s) on board.

Fire extinguishers are required as follows:

For boats under 26 feet with enclosed engine, fuel tanks or other spaces:

- 1 size B-I fire extinguisher required.

For boats 26 feet up to 40 feet:

- 2 size B-I or 1 size B-II fire extinguisher(s) required.

For boats 40 feet up to and including 65 feet:

- 3 size B-I or 1 size B-II and 1 size B-I fire extinguishers required.

For boats over 65 feet:

- 3 size B-II fire extinguishers required.

Additionally:

- When a motorboat is equipped with a U.S. Coast Guard-approved fixed fire extinguishing system in the engine compartment, one less B-I extinguisher is required.
- Enclosed engines and fuel tanks are generally found on inboards or stern drives and also on larger outboard boats with built-in fuel tanks.
- Open outboard boats with unenclosed portable fuel tanks and no floorboards, decking, a cabin or other spaces that could trap fuel vapor are not required to carry an extinguisher. However, it is a good idea to carry one.
- Approved types of fire extinguishers are identified by the following marking on the label – “Marine Type USCG Approved” – followed by the type and size symbols and the approval number.

VENTILATION

Motorboats carrying or using any fuel that has a flashpoint of 110 degrees or less (gasoline) in any compartment must be equipped with an efficient ventilating system to remove combustible gases.

This system must consist of at least one intake duct that extends from the deck below the level of the carburetor air intake (or halfway to the bilge) and an exhaust duct that extends from the deck to the lowest portion of the bilge. The cowls of these ducts must be properly trimmed for maximum ventilation.

A power-operated bilge blower is highly recommended and it should be run at least four minutes before starting the engine.

FLAME ARRESTORS

Gasoline engines, other than outboard motors, must be equipped with a U.S. Coast Guard-approved backfire flame arrestor on the carburetor.

MUFFLERS/NOISE LIMITS

- All watercraft motors must have a muffler, underwater exhaust, or other device that suppresses the sound of the motor to levels noted on page 26.
- It is unlawful to modify, equip, sell or operate a motorboat (except under a permit from the county sheriff or U.S. Coast Guard) that exceeds the levels noted on page 26.
- It is illegal to sell or have an altered muffler, muffler cutout, muffler bypass, or any other device designed or installed so that it can be used to continually or intermittently

bypass any muffler or muffler system, or to reduce or eliminate the effectiveness of a muffler or muffler system.

NOISE LEVEL TESTING

Pass-by Test: Noise level test usually performed at a distance of 50 feet—an equivalent reading may be taken at other distances.

- Boats manufactured before January 1, 1982: **84 dBA**
- Boats manufactured January 1, 1982 and after: **82 dBA**

Stationary Idle Test: Noise level test taken at 4 feet above the water and at least 4 feet behind the transom of the boat.

- Boats manufactured before January 1, 1982: **86 dBA**
- Boats manufactured January 1, 1982 and after: **84 dBA**

Officers and deputies may use either or both of these tests at their discretion.

MARINE TOILETS

Under state law, toilets on board watercraft must be no-discharge devices. Waste must be retained on board for proper disposal after returning to shore.

PROTECT YOUR WATERS



By taking a few simple steps, you can help protect Minnesota's lakes and rivers from zebra mussels and other aquatic invasive species.

Aquatic invasive species (AIS) cannot move across the land without help, but when given a lift they can spread almost anywhere. Everyone who recreates in Minnesota's lakes

and rivers has an important role in preventing the introduction and spread of AIS.

Take these actions required by law:

- **CLEAN** all visible aquatic plants, mud and debris off your boat, trailer and other water-related equipment before leaving a water access or shoreland property. It's illegal to transport prohibited invasive plants or animals, whether dead or alive.
- **DRAIN** water-related equipment (boat, ballast tanks, portable bait container, motor) and drain bilge, livewell and baitwell by removing drain plugs **before** leaving a water access. Keep drain plugs out and water-draining devices open while transporting watercraft.
- **DISPOSE** of unwanted bait, including minnows, leeches, worms, and fish parts in the trash. It's illegal to release live bait into a water body, dump worms on the ground or move aquatic animals or water from one water body to another.

Whenever possible, also take these recommended actions:

DRY everything before going to another lake or river, especially if your boat has been in the water or moored for more than 24 hours or if you have recently been in waters infested with zebra mussel or spiny waterflea. To further decontaminate your boat and equipment, do one or more of the following:

- Spray with high-pressure water.
- Rinse with very hot water. The following water temperatures will kill zebra mussels and some other AIS: 120°F for at least 2 minutes or 140°F for at least 10 seconds.
- Dry for at least 5 days.

Check these places on your boat and trailer and remove aquatic plants and animals:

(A) anchor and lines; **(B)** livewell; **(C)** transom well; **(D)** hull; **(E)** rollers **(F)** axle **(G)** lower unit/propeller.

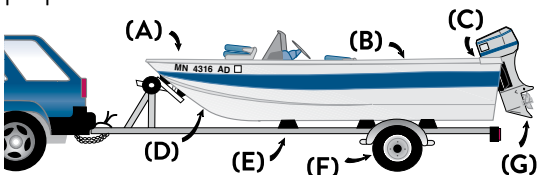

There is also a risk of spreading AIS by other water recreation. Take these additional precautions when engaging in the activities below:

Sailing

Clean aquatic plants, animals and debris from hull, centerboard or bilgeboard well, rudderpost, trailer and other equipment **before** leaving the water access.

Personal watercraft

- Avoid areas with aquatic plants **before** trailering personal watercraft.
- Run engine for 5–10 seconds on the trailer to blow out excess water and vegetation from internal drive, and then turn engine off.
- Clean aquatic plants, animals and debris from hull, trailer, water intake grate and steering nozzle **before** leaving water access.

21-day dry law

A boat lift, dock, swim raft, or associated equipment that has been removed from any water body may not be placed in another water body until a minimum of 21 days have passed.

Report new infestations

If you suspect a new infestation of an aquatic invasive plant or animal, note the exact location,

take a photo or keep the specimen. Then contact your local DNR AIS specialist at 888-646-6367 or 651-259-5100. Visit mndnr.gov/AIS for more information.

Affirmation

In 2016, an AIS affirmation was added to new watercraft and nonresident fishing licenses. License applicants are required to affirm they have read and understand a provided summary of AIS laws. No fees are associated with the affirmation. Learn more at mndnr.gov/affirmation.

GENERAL OPERATION

ENFORCEMENT

DNR's conservation officers and county sheriff deputies enforce Minnesota's boat and water safety laws. All state and county enforcement craft will be marked on both sides or with a blue state pennant. Some waters of the state are also under federal jurisdiction. The U.S. Coast Guard and the National Park Service enforce federal boating regulations.

Whenever enforcement officers contact you, you are required to stop and allow them to come alongside. The officer may warn you about a storm or caution you about the way you're operating your boat. Always remember that a key job of these officers is to ensure your safety afloat.

Violation of a boat and water safety statute or rule is a misdemeanor, with some exceptions for repeat violations or more serious offenses.

Boaters on some waters may be able to request assistance by using a marine radio. Examples of these areas are Lake of the Woods, Lake

Superior, the Lower St. Croix River, Mississippi River downstream from Minneapolis, Minnesota River downstream from Shakopee and Lake Minnetonka.

AGE OF OPERATORS

- You can obtain an operator’s permit by successfully completing the Minnesota, NASBLA-approved boating safety course. It is available at mndnr.gov/boatingcourse.
- If you are age 12–17, visiting Minnesota, and already possess a valid watercraft operator’s certificate/permit issued by your home state, you don’t need to obtain another one from Minnesota.
- If you do not have a certificate from your state, you may obtain one from Minnesota by successfully completing the DNR’s boating safety course. It is available at mndnr.gov/boatingcourse.
- We recommend that adults take the Minnesota boating course to enhance their knowledge and safety.
- Many boat insurance companies offer discounts to boat owners who have taken an approved boating safety course.

MOTORBOAT OPERATOR AGE RESTRICTIONS

(Personal watercraft see page 43)

OPERATOR AGE	RESTRICTIONS
LESS THAN 12 YEARS	<ul style="list-style-type: none"> • 25 hp or less—no restrictions. • More than 25 through 75 hp—must have someone at least 21 years old on board within immediate reach of the controls. • More than 75 hp—not allowed to operate even with an adult on board.

OPERATOR AGE	RESTRICTIONS
12 -17 YEARS	<ul style="list-style-type: none"> • 25 hp or less–no restrictions. • More than 25 hp–must either have: <ul style="list-style-type: none"> – a watercraft operator’s permit, or – someone at least 21 years old on board and within immediate reach of the controls.

NAVIGATION RULES

Passing

- When overtaking another watercraft going in the same direction, the craft being overtaken must maintain course and speed.
- The passing watercraft must keep a sufficient distance to avoid collision or endangering the other craft from its wake.

Meeting

- When two watercraft approach each other “head-on,” each must alter course to the right to avoid collision.
- If the two watercraft are far enough to the left of each other, no change in direction is needed for safe passage. Both watercraft will maintain their course and speed to pass clear of each other.
- Keep to the right in narrow channels.

Crossing

If two watercraft approach each other at a right angle, the watercraft to the right shall have the right-of-way.

Nonmotorized Craft

Nonmotorized craft (sailboats, canoes, etc.) have the right-of-way over motorized craft in all situations, except when the nonmotorized craft is overtaking or passing.

Commercial Vessels

Small craft shall not insist on the right-of-way when in the path of large commercial vessels, which are limited in maneuverability.

Emergency Craft

All watercraft will yield right-of-way to an authorized watercraft displaying a red or blue flashing light.

MOVE OVER LAW

When approaching and passing a law enforcement watercraft with its emergency lights activated, the operator of a watercraft must safely move the watercraft away from the law enforcement watercraft and maintain a slow no-wake speed while within 150 feet of the law enforcement watercraft.

WATERWAY MARKERS – AIDS TO NAVIGATION

Waterway markers show navigable channels, denote unsafe areas, direct traffic, control speed, protect resources and serve other functions.

Official markers are usually placed by the U.S. Coast Guard, state, county or local governmental unit. Private markers of any type may not be placed in the water overnight without a permit from the county sheriff.

If a buoy or sign is lighted, it will usually display the color and flash characteristics noted on

following pages. “Flashing” means not more than 30 flashes per minute. “Quick-flashing” means at least 60 flashes per minute and generally indicates caution or danger.

Channel Marker Buoys

- All-green and all-red companion buoys indicate that the boating channel is

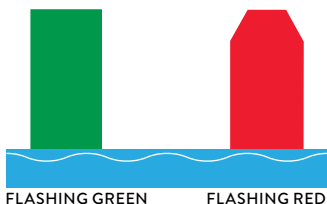

- Red buoy is on the right side of the channel when facing upstream.

Signs can be substituted. For example, a green square sign is the same as a green buoy and red triangular sign is the same as a red buoy - these are often called “daymarks.” They can be used to mark each side of a channel, which is common on the Mississippi River below the Twin Cities. A red-white octagonal sign can be used to mark the center of a channel.

Red and white and black and white buoys

- Red-white striped buoys (usually with a red topmark) indicate the center of a channel and should be passed closely on either side.
- Black and white striped buoys (formerly red-white striped) indicate there is a shoreward obstruction and that you should not pass between it and the nearest shore.

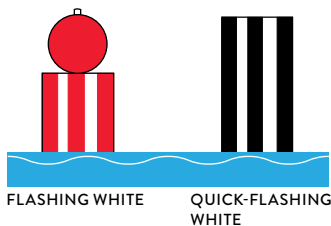

Regulatory Buoys and Signs

Boats Keep Out – A white buoy or sign with an orange diamond and cross means that boats must keep out of the area. Black lettering on the buoy or sign gives the reason for the restriction, for example, SWIM AREA.

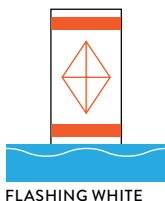

Danger – A white buoy or sign with an orange diamond warns boaters of danger - rocks, dams, rapids, etc. The source of danger will also be lettered in black. In winter, ice hazards may also be identified with this marker in the form of a sign.

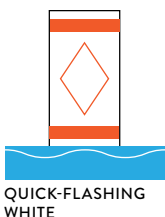

Controlled Area – A white buoy or sign with an orange circle and black lettering indicates controlled or restricted areas on the water. The most common restriction is slow no-wake speed. Slow no-wake means operating your boat at the slowest possible speed necessary to maintain steerage, but in no case greater than five miles-per-hour.

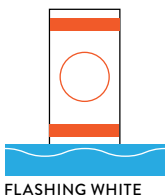

Information – A white buoy or sign with an orange rectangle provides the boater with information or directions. Information will be lettered in black.

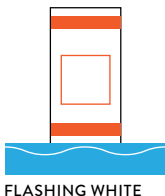

Mooring Buoys – Buoys designed for mooring boats are all-white with a blue stripe midway between the top and the waterline. A minimum of 16 square inches of white reflector, part of which must be visible from any direction, is required on all mooring buoys. (Obtain a permit from the county sheriff before placing a mooring buoy in the water.)



Here are some tips on waterway markers:

- Waterway markers, especially buoys can move off station due to wind, waves, current, ice or other reasons.
- Buoys and other waterway markers may not be present outside of the normal boating season. Check locally before heading out.
- Red and green channel markers may be numbered: green (odd) and red (even).
- Size specifications for buoys:
 - For all buoys except mooring buoys, the minimum height above water is 36 inches and the minimum diameter is 9 inches.
 - For mooring buoys the maximum size is 24 inches in diameter, if spherical, or a maximum of 24 inches wide if some other shape. Mooring buoys must extend at least 8 inches above the water.

ON THE WATER LAWS AND RULES

It's against the law:

- To operate a watercraft in a careless or reckless manner.
- To operate a watercraft so its wash or wake endangers, harasses, or interferes with any person or property.
- To operate a watercraft so it obstructs ordinary navigation.

- To operate a watercraft within an area legally marked off as a swimming area, or within 150 feet of a diver's warning flag (see page 48).
- To ride or sit on the gunwales, bow, transom, or decking over the bow, sides or stern of any motorboat while underway, unless it is equipped with an adequate railing. It is also illegal to operate a motorboat while any person is riding or sitting in a manner as just listed.
- To chase wildlife with a motorboat, or operate a boat where it is prohibited – including marked spawning beds. Avoid traversing any emergent or floating vegetation, if possible.
- To intentionally obstruct a seaplane.
- To attach a watercraft to any buoy, except a mooring buoy, or to tamper, remove, or destroy a navigational aid.
- To deposit or leave refuse in or upon the waters of the state or at public access areas.

CAPACITY AND OVERLOADING

The boat's operator must limit the total horsepower, weight and maximum number of passengers to that shown on the capacity plate installed by the boat's manufacturer. It is unlawful and dangerous to load or power your boat beyond its maximum capacity. Capacity is reached by either the maximum number of people or maximum weight, whichever is met first.

BOATING WHILE IMPAIRED (BWI)

- Operating a motorboat while under the influence of alcohol, a controlled substance (or its metabolite), or an intoxicating substance is unlawful.

- Operators who are impaired may be required to take tests by an enforcement officer to determine the presence of these substances. There is a penalty for refusal. BWI test failures, convictions, and refusals are recorded on the violator's driver's license record.

Most of the BWI law is found in the motor vehicle statutes. The alcohol concentration for impaired operation is .08.

Possible penalties for impaired operation:

- Fines.
- Possible jail time.
- Loss of motorboat, off-road vehicle and motor vehicle operating privileges.

In addition to the above penalties, those who refuse testing will also be subject to a separate and more severe criminal charge for refusal and loss of their motorboat, off-road vehicle and motor vehicle operating privileges for one year, immediately upon refusal.

If any of the following aggravating factors are involved, the offense is a gross misdemeanor (a fourth conviction in 10 years can result in a felony penalty):

- An alcohol concentration of .16 or more.
- Prior DWI convictions or refusals of any kind in the past 10 years.
- A child less than 16 years old is on board the motorboat.

Penalties will increase with any of the aggravating factors or a refusal, and can include the following:

- A higher fine.
- Mandatory jail time.
- Longer revocation times for operating privilege loss.
- Loss of motor vehicle license plates.
- Forfeiture of the motorboat and trailer being operated at the time of violation.

The BWI law does not prohibit drinking alcoholic beverages aboard boats nor having an open bottle. The BWI law applies to operators of motorboats that are not anchored, beached, moored, docked or being rowed or propelled by nonmechanical means at the time of the offense.

TOWED AND WAKE SPORTS

Laws and Rules

- It is unlawful to make a wake for a wake surfer or tow a person on water skis, wakeboard, tube, or similar device unless there is a mirror providing the operator a wide field of vision to the rear, or unless another person in the towing watercraft is continuously observing the person wake-surfing or being towed.
- Water-skiing, tubing, wake-surfing and similar acts are prohibited between one-half hour after sunset to sunrise of the following day.
- Tow ropes may not be longer than 150 feet in length, unless a permit is obtained from the county sheriff.
- A wearable U.S. Coast Guard-approved life jacket must either be worn by the person being towed, or carried in the towing watercraft.

For regulations on towing people with a personal watercraft (Jet Ski, PWC, etc.) – see page 41. Also, there may be local restrictions on towing (especially in the Twin Cities area) – see page 54.

Tubing

The maneuvers of the tow boat affect tubes in a way that is similar to a clock's pendulum. Riders do not have the directional control that water skiers have, so the boat operator needs to take special precautions.

Accidents are most often caused by:

- The tube hitting a wake and flipping, throwing the rider(s) into the water or against each other.
- Tubes swinging out as a boat turns–hitting an object or throwing the occupant off.
- Injuries caused by the tow line and when two tubes being towed by the same boat collide with each other.

Towed and Wake Sports Safety Tips

- Keep speeds low (most tube manufacturers recommend a maximum of 15–20 mph) to reduce the likelihood and consequences of an accident.
- Make turns gradually and away from shore, other boats, swim rafts or docks, to reduce the chance of collision and property damage.
- Tow only a single tube at a time.
- It is critical that everyone being towed wear a life jacket.
- It is also a good idea to have an observer in the towing craft, in addition to a wide-angle mirror.
- Stay back at least 20 feet behind the boat to avoid carbon monoxide exposure.

- Many manufacturers also recommend that no one under 6 years old be towed on a tube, and that you follow the manufacturer's recommended passenger weight limits.

Own Your Wake

Large wakes produced by some watercraft operated at certain speeds can cause a number of negative impacts, including:

- Shoreline erosion, which results in impaired water quality and property loss.
- Damage to others' property, including docked boats.
- Hazards to public safety both on the water (swimmers, paddlers) and on shore.

PERSONAL WATERCRAFT

Personal watercraft (PWC) are also known as Jet Skis or Wave Runners. Personal watercraft is defined by law as a motorboat that is:



- Powered by an inboard motor powering a water jet pump or by an outboard or propeller-driven motor.
- Designed to be operated by a person or persons sitting, standing, or kneeling on the craft, rather than in the conventional manner of sitting or standing inside a motorboat.

All personal watercraft are considered motorboats and therefore, any regulations that govern other motorboats (such as fishing boats, cabin cruisers, etc.), also govern personal watercraft.

Personal Watercraft Laws

In summary, the law requires that:

- Anyone operating or riding on a personal watercraft must wear a U.S. Coast Guard-approved wearable life jacket that is compatible with that activity (check the label).
- Personal watercraft must travel at slow no-wake speed (5 mph or less) within 150 feet of nonmotorized boats, shore (unless launching or landing skiers directly to or from open water), docks, swim rafts, swimmers, or any moored or anchored boat.
- Operation of personal watercraft is allowed only from 9:30 a.m. to 1 hour before sunset.
- If you tow a person on water skis, or any other device, there must be an additional person on board the personal watercraft to act as an observer. (The observer does not have to be facing backward.)
- Factory-installed or factory-specified wide-field rearview mirrors are allowed instead of an observer when pulling a skier or other device (tube, kneeboard, etc.).
- After-market mirrors, stick-on mirrors, motorcycle mirrors, etc., do not qualify for the observer exemption.
- The skier/knee-boarder etc. must also be wearing a life jacket or there must be one on board the personal watercraft for the skier.
- If the machine is equipped by the manufacturer with a lanyard-type engine cutoff switch, it must be attached to the person, life jacket or clothing of the operator when underway.

- You may not operate a personal watercraft if any part of the spring-loaded throttle system has been removed or tampered with so it interferes with the return-to-idle system.
- You may not chase or harass wildlife.
- You may not travel through emergent or floating vegetation at greater than slow no-wake speed.
- You may not operate a personal watercraft in a manner that unreasonably or unnecessarily endangers life, limb or property.
- You may not weave through congested watercraft traffic, or jump the wake of another watercraft within 150 feet of the other watercraft. This includes other personal watercraft.
- A personal watercraft rules decal issued by the DNR needs to be on the craft in full view of the operator.
- You may not operate a personal watercraft while facing backward.
- It is unlawful for the owner of the personal watercraft to permit its operation in violation of the age restrictions (see next page).
- Some lakes have additional restrictions, see mndnr.gov/boatingsafety and click on local water restrictions.
- A person on a waterjet propelled accessory to a personal watercraft is operating a personal watercraft and must follow all regulations.

PERSONAL WATERCRAFT OPERATOR AGE RESTRICTIONS REGARDLESS OF HORSEPOWER

(other motorboats see page 30)

OPERATOR AGE	RESTRICTIONS
LESS THAN 13 YEARS	<ul style="list-style-type: none">• Cannot operate – even with an adult on board.
13 YEARS	<ul style="list-style-type: none">• must have either someone at least 21 years old on board, or• a watercraft operator’s permit and be in visual supervision by someone at least 21 years old.
14 –17 YEARS	<ul style="list-style-type: none">• must have either a watercraft operator’s permit, or• someone at least 21 years old on board.

SELLING AND RENTING PERSONAL WATERCRAFT

Personal watercraft dealers are required to distribute a summary of the laws and rules governing personal watercraft. They must provide instruction regarding laws governing personal watercraft, as well as safe operation of the craft, upon request by a purchaser.

Rental operators must provide required safety equipment and a copy of the personal watercraft laws free of charge, as well as instruction on laws and operation of the craft.

Both personal watercraft dealers and rental operations must keep a signature record of all those who buy or rent personal watercraft.

This record is to indicate that the buyer or renter has been provided with a copy of the personal watercraft laws and has read them.

In addition, those persons less than 18 years of age must show their watercraft operator's permit before renting a personal watercraft, and the permit number must be recorded on the form by the rental agent. These forms, available from the DNR Boat and Water Safety Program, must be retained for at least six months, and must be available for inspection by DNR conservation officers or county sheriff's deputies during normal business hours.

GENERAL WATERCRAFT LAWS THAT APPLY TO PERSONAL WATERCRAFT

Personal watercraft must follow the same laws which apply to general watercraft, including:

- All personal watercraft must display valid registration decals and registration numbers on the forward half of both sides of the craft (see pages 9–12).
- Your watercraft license card must be kept on board your craft when it's in use.
- All personal watercraft with enclosed engine or fuel compartments (almost all personal watercraft fall into one or the other category) must carry a fully charged, readily accessible, U.S. Coast Guard-approved fire extinguisher.
- Personal watercraft may not exceed the maximum watercraft noise levels. Also, you may not modify any motorboat (including personal watercraft) in a way that amplifies or increases the noise it emits above watercraft noise limits. No person shall operate or sell a motorboat with any such

modification, or sell parts to facilitate such modification.

- It is unlawful to operate a personal watercraft while intoxicated.

Personal watercraft tips

Many personal watercraft accidents involve new and inexperienced riders who haven't received adequate training. If you or your family own a personal watercraft or are going to purchase one, ask the dealer to provide you with any safety information they may have for your craft. All machines are supplied with an owner's manual and many come equipped with a safety video. Have everyone who operates the machine watch the video and read the safety information.

Avoid explosions

- Before starting check the engine compartment for gasoline vapors, especially after refueling or when the engine is running poorly.
- Don't start the engine and seek repair if vapors are present.

Give it the gas

Many PWC accidents have occurred because the operators forgot (or never learned) that a personal watercraft will not turn unless you apply the throttle. The only way it will turn is if there is water spraying out the steering nozzle.

Be a good neighbor

- Talk to your neighbors.
- Don't operate in the same area for a long period of time.
- Operate far from shore and other boaters.

RENTING WATERCRAFT

- All watercraft offered for rent are subject to periodic inspection by the county sheriff. An inspection decal will be issued to each craft that passes this inspection.
- The rental agent is required to provide U.S. Coast Guard-approved life jackets in serviceable condition, as well as all other required safety equipment.
- All rental craft must meet the federal manufacturer's flotation requirements as of the date they were constructed.
- A boat may not be rented to a person who is under the influence of alcohol or a controlled substance.
- A rental boat loaded beyond its weight capacity or powered beyond its horsepower capacity may not leave the place where it is rented.
- Boats may not be rented, or offered for rent, unless they are in safe condition.
- See page 43 for regulations governing personal watercraft dealers and rental operators.

ACCIDENTS

If an accident occurs, follow these simple steps:

- Call 911.
- Stop at the scene and assist others who are in trouble if you can do so safely (required by law).
- Don't risk your life or the lives of others to save equipment.
- If a second boat or other property is involved, exchange your name and boat number with the other operator or owner (as required by law).

- The county sheriff investigates all watercraft accidents, follow their instruction.
- The following accidents must be reported to the county sheriff:
 - Property damage of \$2,000 or more.
 - Personal injury.
 - A fatality.

This is required by law.

OTHER WATER ACTIVITIES

PADDLING

Canoes, kayaks and stand-up paddleboards are all considered watercraft in Minnesota.

Paddling Safety

- Always wear a U.S. Coast Guard-approved life jacket.
- Keep your balance. Stay low, move slow.
- Check your equipment and your skills before attempting a paddling trip.
- Check river levels at mndnr.gov/watertrails
- Be a competent swimmer.
- Tell someone where you are going, when you are coming back and when to call for help.
- Paddle with a friend. Safety increases with numbers.
- Be aware of hazards like dams, rapids, current and big waves.
- Dress for the weather and water temperature. Be prepared for cold water immersion.

- Avoid paddling under the influence of drugs or alcohol.
- Learn how to get out of, hang on to and re-enter your capsized watercraft.
- Take the free BoaterExam Paddle Sports Safety Course online or other paddling safety courses through the American Canoe Association.
- Wear bright clothes, carry a whistle and a white light.

Laws:

- Nonmotorized craft over 10 feet require registration in Minnesota.
- A U.S. Coast Guard-approved wearable life jacket is required for each person on board a watercraft.
- Children under 10 years old are required to wear a life jacket.

SCUBA DIVING

Scuba divers must display a warning flag when diving.

Scuba diving laws and rules:

- Boats not involved with the diving operation must remain 150 feet away from a flag.
- No more than four divers shall dive under one flag.
- Divers must remain within 50 feet (measured horizontally) of the warning flag.
- If a group of divers is using a contained area, the perimeter of the area must be marked. The area must be outside the normal area of navigation. These markings must consist of the official diver's flag and must be placed around the perimeter of the diving area at intervals of not more than 150 feet.



- Persons who dive from one hour after sunset to sunrise on the following day must carry a diver's light visible when above the water for a distance of 150 feet.
- Scuba or skin diving while in possession of a spear is unlawful from sunset to sunrise.
- Do not place a diver's flag where it will obstruct navigation.

The diver's flag must:

- Measure at least 15 inches horizontally and 12 inches vertically.
- Both sides must have a red-colored background bisected diagonally by a 3-inch wide white stripe.
- There is also a blue and white diver's flag authorized under the federal rules of the road.

The diver's flag may be displayed on a watercraft or float or be anchored to the bottom. The top of the flag must be at least 30 inches above the surface, however.

SWIMMING AREAS

Required Permits

Obtain a permit for swimming area markers from the county sheriff. No swimming marker may obstruct navigation or unduly interfere with public use of the water.

Sheriffs or conservation officers may direct the owner to move such markers or remove them from the water.

Individual Swim Areas

The owner or lessee of shoreline property may mark off up to 2,500 square feet, but not more than 50 feet along the lake frontage, for a swimming area directly in front of his or her property. No watercraft

may enter this area but the water remains public waters.

Markers to designate an individual swimming area must:

- Be white with an orange diamond and cross on each side. A white gallon plastic bottle with the orange markings painted on each side fulfills this requirement.
- Extend out of the water at least 6 inches but no more than 14 and should be spaced no more than 15 feet apart.

Public Swim Areas

Public swimming areas (including resorts) must be marked off with the standard 9 inches or larger “Swim Area” buoy. This buoy is white with an orange band at the bottom and top. Between the orange bands is an orange diamond with a cross inside. The design appears on opposite sides of the buoy. Above or below the diamond shapes are the words SWIM AREA in black, 2-inch lettering. Marker buoys must not be spaced more than 75 feet apart. Smaller all-white markers may be used to add definition to the area marked by regulation markers. Size limits are at the discretion of the county sheriff.



TEMPORARY STRUCTURES, DOCKS AND BUOYS

Docks that extend from shore may not interfere with navigation and generally require no permit, unless they exceed certain width or number of mooring space limits.

For current information, see the DNR publication “Docks and Access in Public

Waters” by checking the DNR website: mndnr.gov/publications/waters or contacting the DNR Information Center at 651-296-6157 or 888-646-6367. (There may be local ordinances on docks.)

Structures such as swimming rafts, boat lifts, buoys, slalom courses, ski jumps, etc., which do not extend from shore, cannot be in the water between sunset and sunrise unless allowed under permit issued by county sheriff.

All structures placed under a permit must have the permit number painted on them. In addition, the structure or buoy must either have a light visible in all directions or be reflectorized to reflect light from all directions.

Persons placing structures on joint federal-state waters may need a permit from the U.S. Army Corps of Engineers.

SPECIAL EVENTS

Persons holding regattas, races, tournaments, or other competition or exhibition events on the water must first obtain a permit for the event from the county sheriff.

Those holding events on commercially-navigable, joint-jurisdictional waters (primarily Lake Superior, the Mississippi River downstream from St. Anthony Falls, the Minnesota River east of Shakopee, and the St. Croix River from Stillwater downstream) must obtain a marine event permit from the U.S. Coast Guard.

PUBLIC WATERS AND WATER APPROPRIATION PERMITS

Any work in the bed of public waters (below the ordinary high water level), such as dredging, filling, draining, and placement of structures, or water appropriations of more than 10,000 gallons per day or 1 million gallons per year requires a permit from the DNR Ecological and Water Resources Division.

AQUATIC PLANT MANAGEMENT PERMITS

Any control of aquatic vegetation, either native species or non-native invasive species, in public waters (lakes, rivers, or wetlands) or the control of other aquatic nuisances (e.g., swimmer's itch) is regulated by the DNR.

Those activities which require a permit, as well as activities that can be done without a permit, are summarized on pages 52–54. For more information go to mndnr.gov/apm or search for “mndnr apm.”

An aquatic plant management permit is needed for:

- Destruction of any emergent vegetation such as cattails and bulrushes.
- Cutting or pulling by hand or by mechanical means, submerged vegetation in an area larger than 2,500 square feet.
- Applying herbicides or algaecides.
- Moving or removing a bog of any size that is free-floating or lodged in any area other than its place of origin in public waters.
- Transplanting aquatic plants into public waters.
- Use of automated aquatic plant control devices such as Crary Weed Roller.

- Physical removal of floating-leaf vegetation from an area larger than a channel 15 feet wide extending to open water.

When an aquatic plant management permit is NOT needed:

To maintain access to your property, a boat docking site or swimming area a lakeshore property owner may mechanically (i.e. cut or pull) clear the following without a permit:

Submerged Vegetation

- The area to be cleared must be no larger than 2,500 square feet.
- The cleared area must not extend more than 50 feet along the shoreline or one-half the length of your shoreline, whichever is less.

Floating-Leaf Vegetation

- A boat channel 15 feet or less in width extending to open water may be maintained.
- The channel must take the most direct route to open water and remain in the same location each year.

Vegetation that is cut or pulled must be immediately and permanently removed from the water and disposed of on high ground where it will not re-enter the lake. You cannot use hydraulic jets to control aquatic plants or to remove muck.

What is not allowed:

- Excavate the lake bottom for aquatic plant control.
- Use hydraulic jets to control aquatic plants or remove muck.

- Destroy or prevent the growth of aquatic plants by using lake bottom barriers.
- Remove aquatic vegetation within posted fish-spawning areas.
- Remove aquatic plants from an undeveloped shoreline.
- Remove aquatic plants where they do not interfere with swimming, boating or other recreation.

LOCAL BOATING RESTRICTIONS

Certain bodies of water in Minnesota have local restrictions as to the type and size of watercraft or motor horsepower, areas which can be used by boats, boat speed, times for use, and minimum distance between boats. With few exceptions, local restrictions on boat use on Minnesota waters must be approved by the DNR and posted at public access points.

Questions regarding lakes or rivers with local restrictions can be directed to the appropriate county sheriff, or the DNR Information Center. A list of approved local restrictions is posted on the DNR Web page at: mndnr.gov/boatingsafety. Click on local water restrictions.

BOAT TRAILERS

Dimensions

- The maximum length of a boat trailer and boat is 45 feet.
- No trailer load may exceed 8 ½ feet wide or 13 ½ feet high.

Lights

- Two red tail lights, license plate light (not required on trailers with permanent registration) and two red reflectors are required on the rear of all trailers.
- Signal and brake lamps are recommended on all trailers and required whenever the signals of the towing vehicle are not visible to the other drivers.
- Trailers over 80 inches wide also require front and rear clearance lamps, and combinations over 30 feet long must have front and rear marker lamps.

Hitch and Coupling

- The hitch and coupling of the trailer must meet state standards.
- Safety chains or cables are required.

Brakes

Brakes of adequate effectiveness are required on all trailers of 3,000 pounds or more gross weight.

Following

Drivers of vehicles towing a trailer must maintain a distance of 500 feet between their vehicle and the vehicle ahead.

More information on trailer laws is available from the Minnesota Department of Public Safety in St. Paul or from any Minnesota State Patrol office.

Before Driving

- Check tires, test trailer brakes and signal lights, crisscross the safety chains.
- Properly secure tie down straps, winch/bow line, and all gear in the vessel.
- Tilt and secure the engine.
- Remove the drain plug.

Launching

- Prepare to launch away from the ramp.
- Leave the winch/bow line attached, remove tie downs and transfer remaining gear.
- Put the plug in.
- Back vehicle into the water until the vessel floats.
- Unhook bow line, secure vessel to dock or shore and park vehicle and trailer in parking lot.

Retrieving

- Back the trailer into the water so two-thirds of rollers or bunks are submerged.
- Move vessel onto trailer, attach winch/bow line to bow eye, crank the winch to pull the vessel all the way onto the trailer.
- Tow vessel off ramp and out of the way for others.
- Clean, Drain, Dispose all aquatic plants, mud, animals and water.
- Repeat the “before driving” tips.

When the boat landing is busy, the line for launching and loading watercraft is based on the vehicles on land, not the boats in the water. Your time on the boat ramp should be no more than a few minutes. For the courtesy of others, please prepare your boat for launching and secure your boat for travel away from the ramp area.

BOATING EMERGENCIES

RESCUE BREATHING FOR DROWNING VICTIMS

Drowning victims need oxygen before compressions. Follow these steps:

1. Start right away.

2. Provide two rescue breaths as soon as you safely can do so. Usually this is when you are in shallow water or on shore.
3. Once on shore, tilt the head backward so the chin is pointed upward and the air passage is open.
4. Pinch the nostrils to prevent air leakage.
5. Place your mouth over the victim's mouth so that you form an airtight seal.
6. Blow for one second to make the chest clearly rise. Give two rescue breaths.
7. If chest does not rise, re-tilt head and give another breath. If you do not hear air coming, recheck the head and jaw position and clear the victim's mouth.
8. Check victim's pulse. If no pulse, perform CPR. Include breathing!
9. DO NOT STOP! Continue cycles of CPR. Do not stop CPR except in one of these situations:
 - You find an obvious sign of life, such as breathing.
 - An AED is ready to use.
 - Another trained responder or EMS personnel take over.
 - You are too exhausted to continue.
 - The scene becomes unsafe.

FALLING OVERBOARD

Prevent persons from falling overboard:

- Avoid a sudden shift in weight or change in speed. Quick movement can cause a boater to fall overboard or a boat to capsize.

If someone on your boat falls overboard:

- Reduce speed and toss the victim a throwable flotation device.
- Turn your boat around and slowly pull alongside the victim, approaching the victim from downwind or into the current, whichever is stronger.

- Turn off the engine. Pull the victim on board over the stern, keeping the weight in the boat balanced.

CAPSIZING OR SWAMPING

To reduce the risk of capsizing or swamping:

- Don't overload your boat. Balance the load.
- Secure the anchor line to the bow, never to the stern.
- Don't boat in rough water or in bad weather – always wear a life jacket in bad weather.
- If you do fall out or capsize, stay with your boat and try to reboard.
- Most capsized watercraft can still float.
- A craft in the water is also easier for rescuers to locate.
- If you have to remain in the water, do not attempt to swim unless it is to a nearby boat or floating object.

COLD WATER (also see page 4)

- One-third of boating fatalities in Minnesota occur on cold water.
- Always wear a life jacket when on or working near cold water.
- Dress in several layers of clothing under your life jacket.

If you fall into cold water:

- Put on your life jacket, if you are not wearing one.
- Keep boots and clothes on. Almost all clothing, even hip boots and waders, will float for an extended period of time.
- Don't thrash or move about. Excess motion consumes energy and increases loss of body heat.
- Draw your knees to your chest and your arms to your sides, protecting the major areas of heat loss.

- If others are in the water with you, huddle together with your arms around their shoulders.

PROPELLER INJURIES

Each year, people are seriously injured or killed by being hit by a propeller.

- Be sure to turn off your motor any time people are in the water near your boat, especially near the stern.
- Never allow passengers to board or exit from the water when the motor is running. The prop may continue to turn even when the motor is in neutral, or someone could accidentally bump the shift lever.
- Stay away from other boats towing skiers or tubers.
- Never use reverse to pick someone up from the water, instead go around again.
- Don't let passengers sit on the transom, gunwales or bow while underway, unless there are adequate railings to prevent falling overboard.
- Use the engine cut-off lanyard that came with your motor and consider installing propeller safety devices.

THE "CIRCLE OF DEATH"

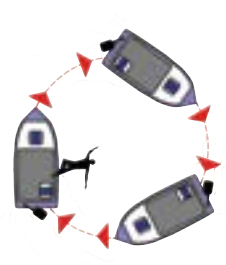

Every year, serious injuries or deaths occur when operators let go of the steering wheel or outboard steering handle while the boat is moving. The steering torque forces the motor to slam left causing the boat

to swerve sharply to the right, throwing the victim into the water.

The boat continues to travel in a circle and returns to strike the victim in the water, inflicting massive propeller wounds. Thus the term “circle of death.”

The way to avoid circle of death accidents is to avoid letting go of the steering wheel or handle until the boat ceases all forward motion.

If you notice that you must apply extra pressure on the steering wheel or handle, have your boat serviced immediately.

For outboards and inboard-outboard craft, corrective measures may involve resetting the boat’s trim tab, the small fin mounted on the anti-ventilation or cavitation plate just behind the prop.

If the motor is equipped with an automatic kill switch, be sure to fasten the lanyard to your life jacket or some article of clothing such as a belt loop.

If you do fall out of your boat, the lanyard, which is attached to the electrical system, disables the motor, keeping the boat from circling back to hit you.

Make sure that clamp-on swivel seats are tightly secured and that seat backs are sturdy enough to withstand the shock of a victim being thrown against them.

CARBON MONOXIDE POISONING

Carbon monoxide (CO) is an odorless, colorless, tasteless gas that can be toxic even in very small quantities since its effects are

cumulative over time. Passengers on any boat with a motor can become victims of carbon monoxide poisoning. If CO is suspected, open all hatches, windows and ports to ventilate.

Common signs of carbon monoxide poisoning include irritated eyes, headache, nausea, weakness and dizziness. These symptoms can often be misdiagnosed as seasickness or intoxication.

Swimmers have died when venturing too close to houseboats' swim platforms while engines or generators were running, and victims have been poisoned while being towed, dragged or sitting too near the stern of a boat. All carbon monoxide poisonings are preventable.

If you suspect carbon monoxide poisoning, call 911!

To help avoid the dangers of carbon monoxide on your watercraft:

- Install marine rated CO detectors and supplement with low level CO detectors.
- Keep air flowing throughout the boat whenever any gas or diesel engine or propane appliance is running.
- Stay away from any area where engine or generator exhaust is vented.
- Do not leave your generator running at night or when anchored.
- Keep your boat and motor properly maintained, including keeping exhaust clamps tight and in place.
- Replace exhaust hoses if there is cracking, deterioration or damage.
- Skiing, dragging, or tubing closer than 20 feet from a motorboat can be fatal from carbon monoxide poisoning—stay well away!

THE DROWNING MACHINE

Boating or swimming near a lowhead dam can be dangerous or even deadly.

Lowhead dams are usually small structures no more than 10 feet high, although some are as low as 6 inches. They may be hard to see from upstream.

In the spring and during other periods of high runoff, however, the dams become very dangerous. The recirculating current created by the water pouring over the dam creates a backwash. This current takes any object – including people wearing life jackets – to the bottom of the stream, releases it to the surface, sucks it back to the face of the dam, and pushes it back to the bottom; the cycle can continue indefinitely. Keep well clear of these structures.

This sign, installed at many dam sites around the state, warns people of the potential dangers of a lowhead dam.



FLOAT PLAN

Before you head out on the water, let someone know where you are going to be boating and when you will return. Give them a description of your car, where it will be parked, and information about your boat and who will be on board.

Be sure to contact that person when you return or prior if you are delayed. It is very important that the person understands they are to call 911 if you do not return on time.

BOATING COURSES

Learn more about boating and water safety. Take the Minnesota DNR boating safety course online or a classroom course taught by the U.S. Coast Guard Auxiliary or U.S. Power Squadrons. For more information go to mndnr.gov/boatingcourse.

BOATING ON LAKE SUPERIOR



As more people turn to the waters of Lake Superior for fishing and boating, the importance of boating safety cannot be overemphasized. Take a boating safety course from the U.S. Coast Guard Auxiliary (USCGA) or U.S. Power Squadrons and get advice from veteran boaters.

Make sure your boat size is appropriate and you have the required safety equipment – have a USCGA Vessel Safety Check (VSC) to make sure.

Weather can change rapidly on the lake – monitor the skies and radio. Water temperatures on Superior are always cold – even in the summer. Always wear your life jacket and consider other survival gear as well.

Carry a VHF marine radio, chart, visual distress signals, Global Positioning System (GPS) and EPIRB (Emergency Position Indicating Radio Beacon) or PLB (Personal Locator Beacon) but remember electronics can sometimes fail.

Let someone know where you are going and when you will return.

Take advantage of the DNR's safe harbors and launch ramps on Lake Superior. Order a free copy of the Lake Superior Boating Guide by contacting the DNR Information Center. You may also download it from mndnr.gov/boatingsafety and click on Lake Superior small craft harbors.

VISUAL DISTRESS SIGNALS

Visual distress signals (VDS) allow boat operators to signal for help in the event of an emergency.

Lake Superior is the only body of water in Minnesota where federal law requires visual distress signals to be carried onboard boats.

- Craft less than 16 feet, boats participating in organized events, nonmotorized open sailboats less than 26 feet and manually propelled boats are NOT required to carry VDS during the daytime, but must carry night VDS when operating between sunset and sunrise.

All VDS must be U.S. Coast Guard approved or certified, in serviceable condition and readily accessible.

Pyrotechnic devices may not be beyond their expiration date. Nonpyrotechnic VDS include:

- Orange distress flag (day signal only).
 - Distress flag which is at least 3 feet by 3 feet with a black square and ball on an orange background.
- Electric distress light (night signal only).

For more complete information on VDS and other federal requirements go to uscgboating.org.

SECURITY

On occasion, you may encounter U.S. Navy ships on Lake Superior or the Duluth–Superior Harbor.

- Stay at least 100 yards from these vessels and operate at slow no-wake speed within 500 yards. If possible, avoid commercial ships and port areas on Lake Superior.
- Observe any restricted areas near power plants, dams and bridges and when possible, avoid anchoring near these areas.
- Report any suspicious activity immediately by calling 911 or use your marine radio to contact the U.S. Coast Guard, state or local enforcement officers. The Coast Guard has also established a 24-hour toll-free number at its national response center 800-424-8802.

Suspicious activities could include:

- People appearing to be engaged in surveillance activities, especially around critical or restricted areas.
- Unusual boating activity or unattended boats in unusual locations.

- Persons attempting to buy or rent a boat with cash for a short-term undefined use.
- Large numbers of people on board nonpassenger vessels.
- Unusual nighttime activity or lights flashing between boats.

PUBLIC WATER ACCESS

The Minnesota DNR, county, city, township, tribal and federal government units all provide public water accesses throughout the state.

Minnesota has both trailer and carry-in access sites. Amenities at each access vary, however, most trailer boat launch sites have a concrete ramp and a dock. Restroom facilities are available at the busier sites.

You can view and print free maps, showing public access locations and basic site information, for most counties at the DNR Web page: mndnr.gov/wateraccess or call the DNR Information Center at 651-296-6157, 888-646-6367.

To report a problem at a public access or obtain specific information for a facility, contact the site administrator.

WILDLIFE MANAGEMENT AREAS

For regulations pertaining to the use of motorboats within wildlife management areas, be sure to check the “Minnesota Hunting and Trapping Regulations” handbook or contact the MN DNR Information Center at 651-296-6157 or 888-646-6367.

SUNKEN BOATS AND VEHICLES

Minnesota law requires that watercraft and motor vehicles (including cars, trucks, snowmobiles and ATVs) that sink in a lake or river be removed by the owner within 30 days.

Owners must also notify the county sheriff within 48 hours.

If the watercraft or vehicle is not removed, the local unit of government can remove it and charge the owner two to five times the cost of removal.

Sunrise/Sunset Table for 2021

DAY	APR.		MAY		JUNE		JULY		AUG.		SEPT.		OCT.	
	SUN-RISE	SUN-SET	SUN-RISE	SUN-SET	SUN-RISE	SUN-SET	SUN-RISE	SUN-SET	SUN-RISE	SUN-SET	SUN-RISE	SUN-SET	SUN-RISE	SUN-SET
1	6:53	7:41	6:02	8:19	5:30	8:53	5:31	9:03	5:59	8:39	6:35	7:49	7:11	6:53
2	6:51	7:42	6:00	8:20	5:29	8:54	5:31	9:03	6:00	8:38	6:37	7:48	7:13	6:51
3	6:49	7:44	5:59	8:21	5:29	8:54	5:32	9:03	6:01	8:36	6:38	7:46	7:14	6:49
4	6:48	7:45	5:58	8:23	5:28	8:55	5:32	9:02	6:02	8:35	6:39	7:44	7:15	6:47
5	6:46	7:46	5:56	8:24	5:28	8:56	5:33	9:02	6:03	8:34	6:40	7:42	7:16	6:45
6	6:44	7:48	5:55	8:25	5:27	8:57	5:34	9:02	6:05	8:32	6:41	7:40	7:18	6:44
7	6:42	7:49	5:54	8:26	5:27	8:57	5:34	9:01	6:06	8:31	6:43	7:38	7:19	6:42
8	6:40	7:50	5:52	8:28	5:27	8:58	5:35	9:01	6:07	8:29	6:44	7:36	7:20	6:40
9	6:38	7:51	5:51	8:29	5:26	8:59	5:36	9:00	6:08	8:28	6:45	7:35	7:21	6:38
10	6:37	7:53	5:50	8:30	5:26	8:59	5:37	9:00	6:09	8:27	6:46	7:33	7:23	6:36
11	6:35	7:54	5:48	8:31	5:26	9:00	5:38	8:59	6:10	8:25	6:47	7:31	7:24	6:35
12	6:33	7:55	5:47	8:32	5:26	9:00	5:38	8:59	6:12	8:23	6:49	7:29	7:25	6:33
13	6:31	7:56	5:46	8:33	5:26	9:01	5:39	8:58	6:13	8:22	6:50	7:27	7:27	6:31
14	6:30	7:58	5:45	8:35	5:26	9:01	5:40	8:57	6:14	8:20	6:51	7:25	7:28	6:29
15	6:28	7:59	5:44	8:36	5:26	9:02	5:41	8:57	6:15	8:19	6:52	7:23	7:29	6:28

Longitude of Minneapolis (from National Oceanic and Atmospheric Administration). Variation approximately 4 minutes to each degree or 1 minute for each 12 miles. Add to determine time for points west, and subtract for points east of Minneapolis.

Sunrise/Sunset Table for 2021 continued

DAY	APR.		MAY		JUNE		JULY		AUG.		SEPT.		OCT.	
	SUN-RISE	SUN-SET	SUN-RISE	SUN-SET	SUN-RISE	SUN-SET	SUN-RISE	SUN-SET	SUN-RISE	SUN-SET	SUN-RISE	SUN-SET	SUN-RISE	SUN-SET
16	6:26	8:00	5:43	8:37	5:26	9:02	5:42	8:56	6:16	8:17	6:53	7:21	7:30	6:26
17	6:24	8:01	5:42	8:38	5:26	9:02	5:43	8:55	6:18	8:16	6:54	7:19	7:32	6:24
18	6:23	8:03	5:41	8:39	5:26	9:03	5:44	8:54	6:19	8:14	6:56	7:18	7:33	6:22
19	6:21	8:04	5:40	8:40	5:26	9:03	5:45	8:53	6:20	8:12	6:57	7:16	7:34	6:21
20	6:19	8:05	5:39	8:41	5:26	9:03	5:46	8:52	6:21	8:11	6:58	7:14	7:36	6:19
21	6:18	8:06	5:38	8:42	5:26	9:03	5:47	8:51	6:22	8:09	6:59	7:12	7:37	6:17
22	6:16	8:08	5:37	8:43	5:27	9:04	5:48	8:50	6:24	8:07	7:00	7:10	7:38	6:16
23	6:14	8:09	5:36	8:44	5:27	9:04	5:49	8:49	6:25	8:05	7:02	7:08	7:40	6:14
24	6:13	8:10	5:35	8:45	5:27	9:04	5:50	8:48	6:26	8:04	7:03	7:06	7:41	6:13
25	6:11	8:11	5:34	8:46	5:28	9:04	5:51	8:47	6:27	8:02	7:04	7:04	7:42	6:11
26	6:10	8:13	5:33	8:47	5:28	9:04	5:52	8:46	6:28	8:00	7:05	7:02	7:44	6:09
27	6:08	8:14	5:33	8:48	5:28	9:04	5:53	8:45	6:30	7:58	7:07	7:00	7:45	6:08
28	6:06	8:15	5:32	8:49	5:29	9:04	5:54	8:44	6:31	7:57	7:08	6:59	7:46	6:06
29	6:05	8:16	5:31	8:50	5:29	9:04	5:55	8:43	6:32	7:55	7:09	6:57	7:48	6:05
30	6:03	8:18	5:31	8:51	5:30	9:03	5:57	8:42	6:33	7:53	7:10	6:55	7:49	6:04
31			5:30	8:52			5:58	8:40	6:34	7:51			7:50	6:02

To determine the exact sunrise and sunset time for your location - log on to esrl.noaa.gov/gmd/grad/solcalc/

AGENCY DIRECTORY

MINNESOTA DEPARTMENT OF NATURAL RESOURCES

Information Center

500 Lafayette Road
St. Paul, MN 55155-4040
Info.dnr@state.mn.us
651-296-6157 or 888-646-6367

Registration and Titling

500 Lafayette Road
St. Paul, MN 55155-4026
651-296-2316 or 800-285-2000

DNR REGIONAL HEADQUARTERS

Region 1: Northwestern

2115 Birchmont Beach Rd. N.E.
Bemidji, MN 56601
218-308-2700

Region 2: Northeastern

1201 E. Highway 2
Grand Rapids, MN 55744
218-328-8780

Region 3: Central

1200 Warner Rd.
St. Paul, MN 55106
651-259-5800

Region 4: Southern

21371 State Highway 15
New Ulm, MN 56073
507-233-1200

LOCAL DNR CONSERVATION OFFICER

To reach a Conservation Officer contact the DNR Information Center. To locate an officer in your area go to mndnr.gov/enforcement and click on Locate a Conservation Officer. You can also contact the Minnesota State Patrol or County Sheriff to reach a MN DNR Conservation Officer.

COUNTY SHERIFFS

Check local listings for County Sheriff's non-emergency numbers. In an emergency call "911" anywhere in Minnesota.

UNITED STATES COAST GUARD

Ninth Coast Guard District

Sault Ste. Marie (for Lake Superior)
906-635-3228

Coast Guard Station Duluth

218-529-3100

Coast Guard Search and Rescue Detachment

- **North Superior-Grand Marais (Seasonal only)**
 - Search and rescue
218-387-2574
 - General
218-720-5412

Eighth Coast Guard District

- **Upper Mississippi**
314-269-2500

United States Army Corps of Engineers

- **St. Paul District**
651-290-5200

WEBSITES

Minnesota DNR, Boat and Water Safety
mndnr.gov/boatingsafety

Minnesota DNR Online Licensing
mndnr.gov/licenses

U.S. Coast Guard – Boating Safety
uscgboating.org

U.S. Coast Guard Auxiliary
cgaux.org

**America's Boating Club
(U.S. Power Squadrons)**
americasboatingclub.org

U.S. Army Corps of Engineers – St. Paul
www.mvp.usace.army.mil

National Park Service

- Voyageurs National Park
nps.gov/voya
- St. Croix Scenic Riverway
nps.gov/sacn
- Mississippi National River and
Recreation Area
nps.gov/miss

Wisconsin DNR
dnr.wi.gov

Canada, Office of Boating Safety
tc.gc.ca

**Minnesota State Legislature
(statutes and rules)**
leg.mn.gov

OPERATOR FLOAT PLAN

DESCRIPTION OF BOAT

Size _____

Color _____

Make _____

Boat's registration number

MN- _____

NAMES AND ADDRESSES OF ALL PEOPLE ON BOARD

TRIP PLAN

When Leaving _____

Where _____

Expect to return by _____

Vehicle parked where _____

Description and license of vehicle

Can be contacted by calling (radio call letters, cell phone, destination)

If not returned by (time) _____

Call the following:

County sheriff at () _____

U.S. Coast Guard at () _____

DON'T FORGET TO CANCEL YOUR FLOAT PLAN WHEN YOU GET HOME.

FREE PUBLICATIONS

The DNR has free boat and water safety publications available at mndnr.gov/boatingsafety or by mail at no charge:

- Danger, Thin Ice (ice safety tips)
- Cold Water Kills
- Carbon Monoxide Warning Stickers (stern, helm, cabin)
- Water Safety for Duck Hunters
- Metro Area Rivers Guide (Twin Cities)
- Mississippi River Guide (Hastings, MN to Iowa)
- Minnesota Boating Guide (this publication)
- Lake Superior Boating Guide
- Water Safety Coloring Book
- H₂O Toons Comic Book
- Recommended Ice Thickness Safety Card
- Personal Watercraft Rules Decal
- Buoy Identification Sticker
- Stop That Prop (warning sticker)
- Check The Drain Plug (sticker)
- Dual Language Boating Safety Tips brochure—English plus one other language—please select language:
 - Hmong
 - Cambodian
 - Laotian
 - Spanish
 - Vietnamese

Contact the DNR Information Center for any Boat and Water Safety publications:

Phone: 651-296-6157

Email: Info.dnr@state.mn.us

BOAT AND WATER SAFETY

500 Lafayette Road

St. Paul, MN 55155-4047

888-646-6367 or 651-296-6157

mndnr.gov

The Minnesota DNR prohibits discrimination in its programs and services based on race, color, creed, religion, national origin, sex, marital or familial status, disability, public assistance status, age, sexual orientation, and local human rights commission activity. Individuals with a disability who need a reasonable accommodation to access or participate in DNR programs and services please contact the DNR ADA Title II Coordinator at info.dnr@state.mn.us, 651-296-6157. For TTY/TDD communication contact us through the Minnesota Relay Service at 711 or 800-627-3529. Discrimination inquiries should be sent to Minnesota DNR, 500 Lafayette Road, St. Paul, MN 55155-4049; or U.S. Department of Homeland Security, Office for Civil Rights and Civil Liberties, Compliance Branch, 245 Murray Lane SW, Building 410, Mail Stop #0190, Washington, D.C. 20528.

This document is available in alternative formats to individuals with disabilities by contacting info.dnr@state.mn.us, 651-296-6157. For TTY/TDD communication contact us through the Minnesota Relay Service at 711 or 800-627-3529.

©2021, State of Minnesota, Department of Natural Resources

Printed on recycled paper containing a minimum of 10 percent post-consumer waste and vegetable-based ink.



BAW_0002_2021



Produced under a grant from the Sport Fish Restoration and Boating Trust Fund, administered by the U.S. Coast Guard.